

LOU

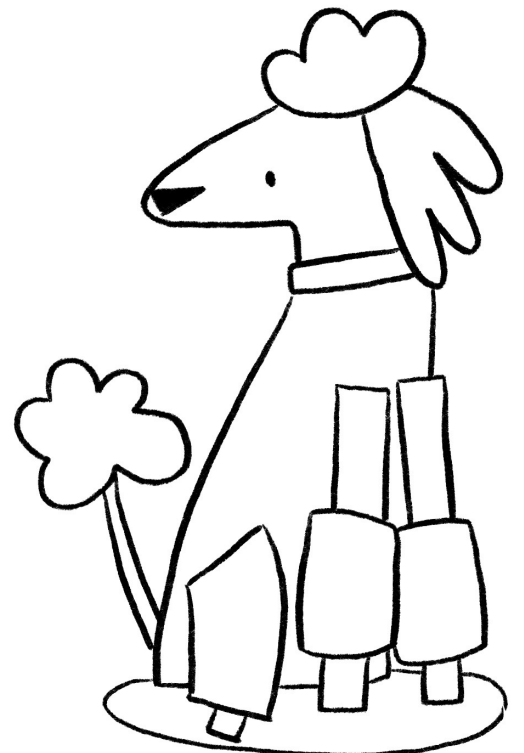
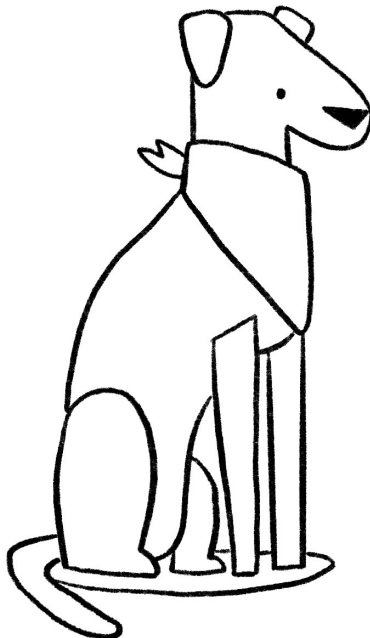
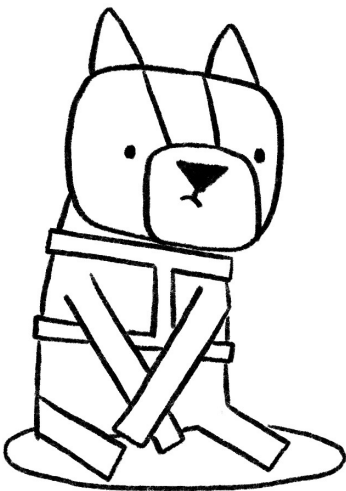
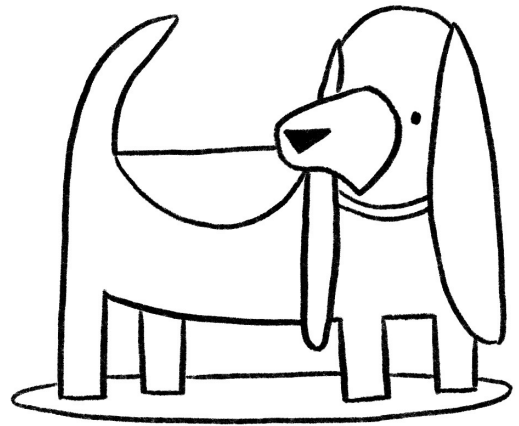
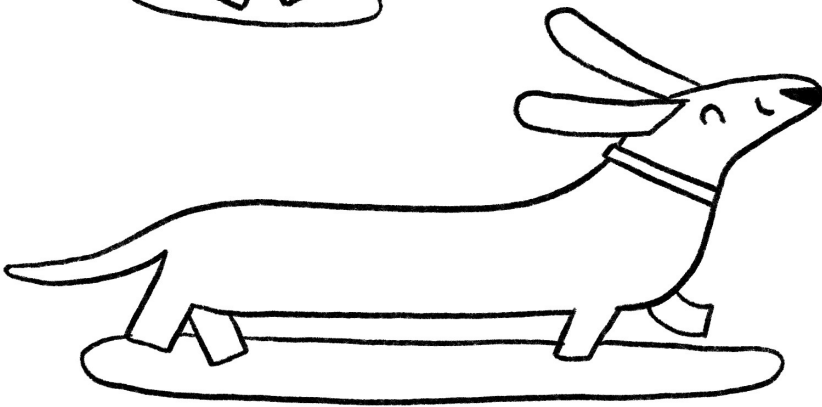
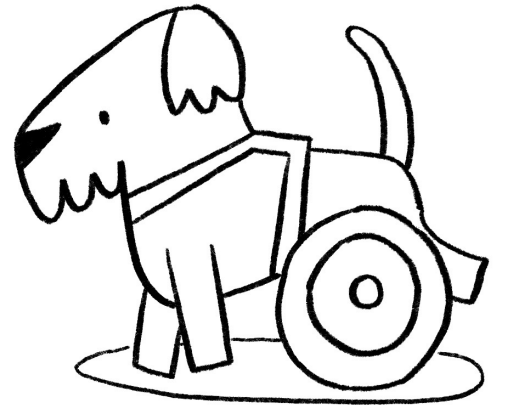
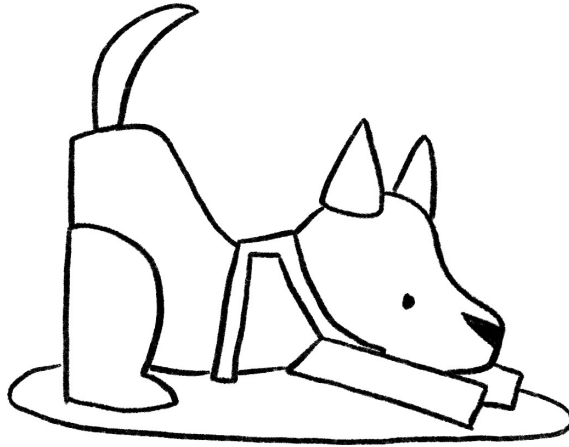
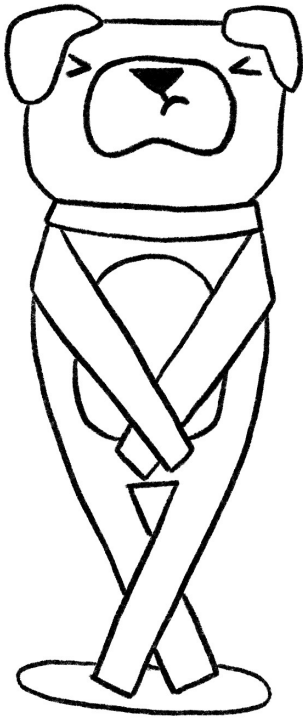

LOU

© Breanna Carzoo

Making

LOU

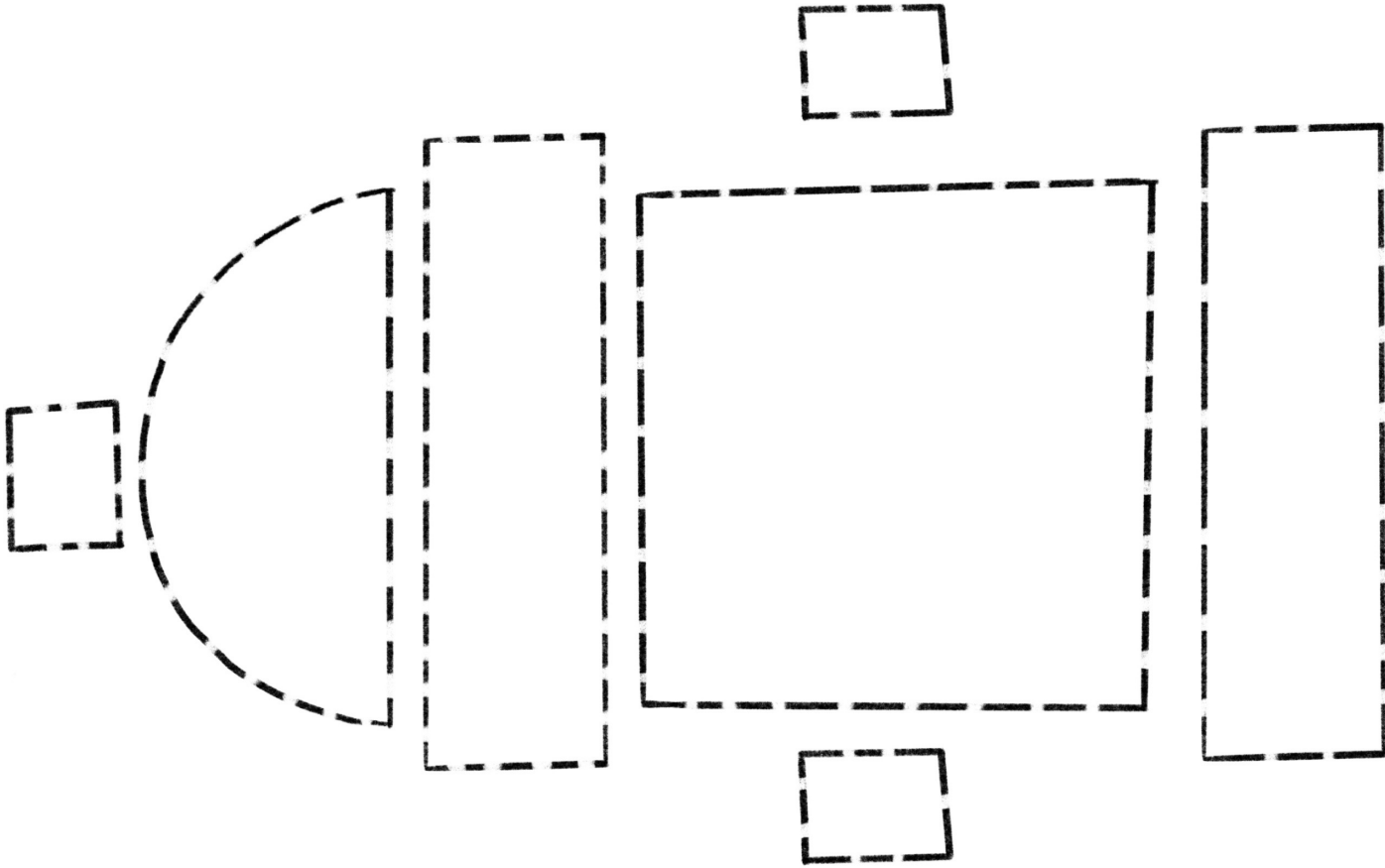

1. Color

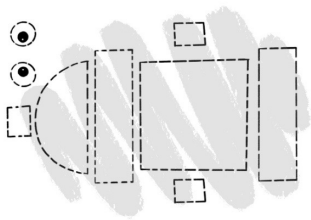
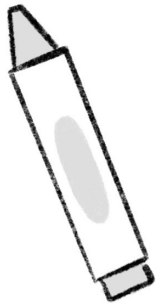

2. Cut

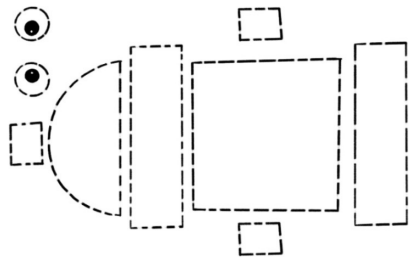
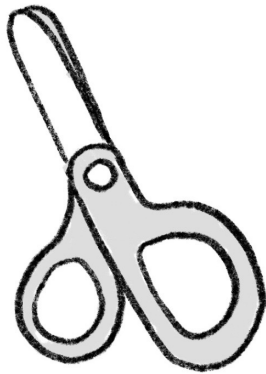

3. Glue

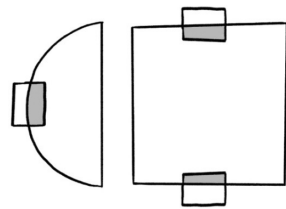

1

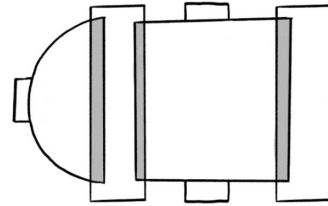

2

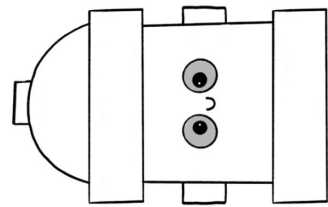

3

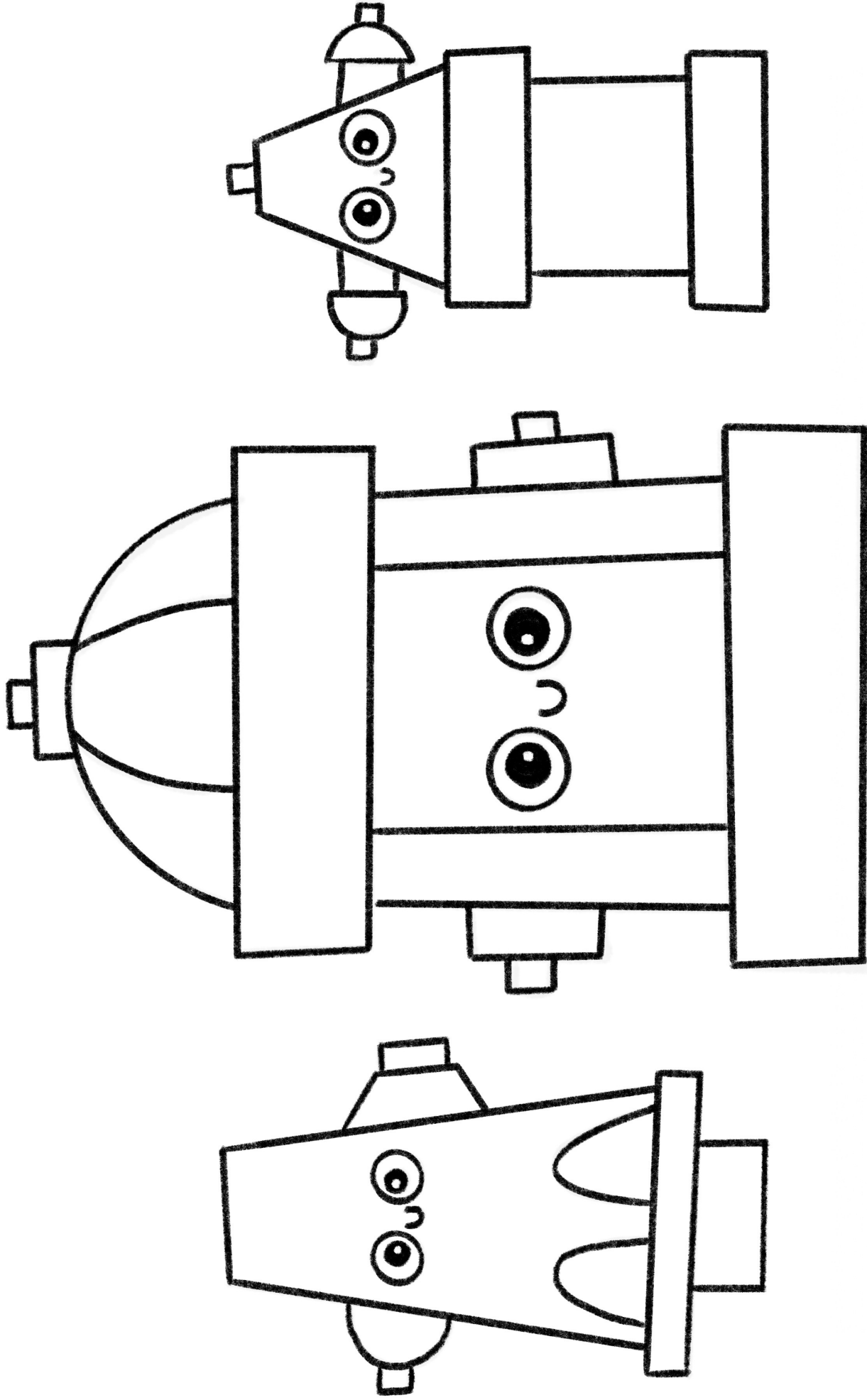

I LOVE FIRE HYDRANTS!